

REV.	ECN.	DATE	DWN	APVD

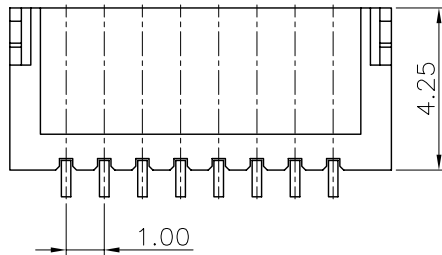
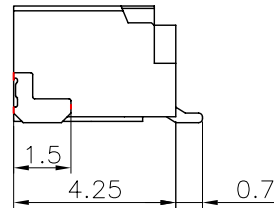
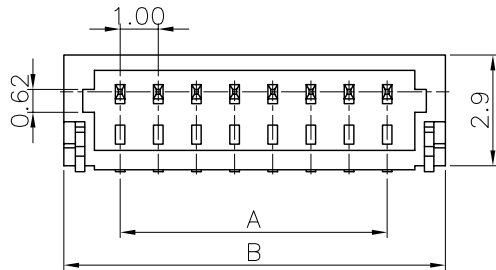

### MATERIAL:

INSULATOR : NYLON 6T, UL 94V-0  
 CONTACT : PHOSPHOR BRONZE  
 CONTACT FINISH : TIN OVER NICKEL PLATED

### SPECIFICATION:

CURRENT RATING : 1A  
 DIELECTRIC WITHSTANDING VOLTAGE : 500V AC PER MINUTE  
 INSULATION RESISTANCE : 100MΩ MIN.  
 CONTACT RESISTANCE : 20mΩ MAX  
 OPERATING TEMPERATURE : -40°C ~ +105°C.

POSITION	A	B
2	1.0	4.0
3	2.0	5.0
4	3.0	6.0
5	4.0	7.0
6	5.0	8.0
7	6.0	9.0
8	7.0	10.0
9	8.0	11.0
10	9.0	12.0
11	10.0	13.0
12	11.0	14.0
13	12.0	15.0
14	13.0	16.0
15	14.0	17.0

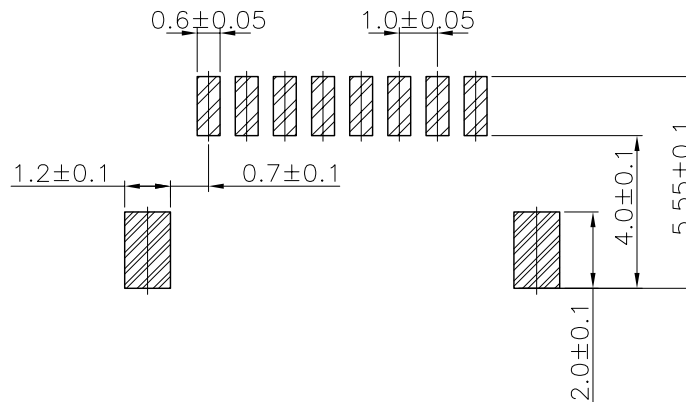

P.C.B. LAYOUT

### Order Information :

H W J 2 1 - 0 6 3 T N C 0 1 - R  
 1 2 3 4 5 6 7 8

1. SERIES NUMBER	HWJ21 : 1.00mm PITCH WIRE TO BOARD WAFER RIGHT ANGLE SMD
2. POSITION	02 ~ 16 & 20
3. CONTACT MATERIAL	3 : PHOSPHOR BRONZE
4. CONTACT PLATING	T : TIN
5. INSULATOR COLOR	N : NATURE
6. INSULATOR MATERIAL	C : NYLON
7. PACKING	1 : TUBE 2 : TAPE & REEL
8. GREEN PRODUCT	R : RoHS



維鼎股份有限公司  
 WEKANG CO., LTD.  
 TEL:886-2-26436301 FAX:886-2-26432714

GENERAL TOLERANCE  
 X.X ±0.25  
 X.XX ±0.15  
 ANGLE TOLERANCE ±1°  
 RADIUS ±0.25  
 HOLE ±0.13

DRAWN. JEAN

DATE 12 - 30 - 2005

DRAWING NO. HWJ21-XX3TNC0X-R C04001

CHECKED. HENRY

DATE 12 - 30 - 2005

TITLE. 1.00mm PITCH WIRE TO BOARD  
WAFER RIGHT ANGLE SMD

APPROVED. HENRY

DATE 12 - 30 - 2005

PART NO. HWJ21-XX3TNC0X-R REV A.0

SIZE A4 UNIT mm SCALE 5/1 SHEET 1 OF 1

REV.	ECN.	DATE	DWN	APVD

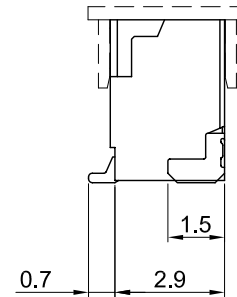
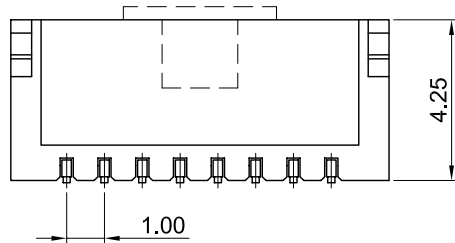
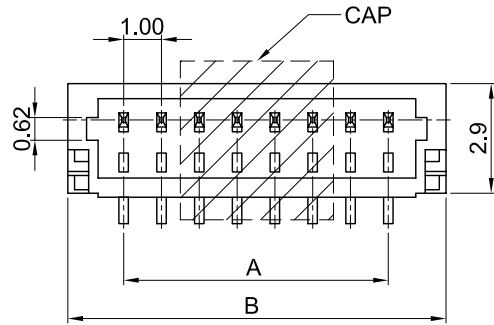

**MATERIAL:**

INSULATOR : NYLON 6T, UL 94V-0  
 CONTACT : PHOSPHOR BRONZE  
 CONTACT FINISH : TIN OVER NICKEL PLATED

**SPECIFICATION:**

CURRENT RATING : 1A  
 DIELECTRIC WITHSTANDING VOLTAGE : 500V AC PER MINUTE  
 INSULATION RESISTANCE : 100MΩ MIN.  
 CONTACT RESISTANCE : 20mΩ MAX.  
 OPERATING TEMPERATURE : -40°C ~ +105°C.

POSITION	A	B
2	1.0	4.0
3	2.0	5.0
4	3.0	6.0
5	4.0	7.0
6	5.0	8.0
7	6.0	9.0
8	7.0	10.0
9	8.0	11.0
10	9.0	12.0
11	10.0	13.0
12	11.0	14.0
13	12.0	15.0
14	13.0	16.0
15	14.0	17.0
20	19.0	22.0

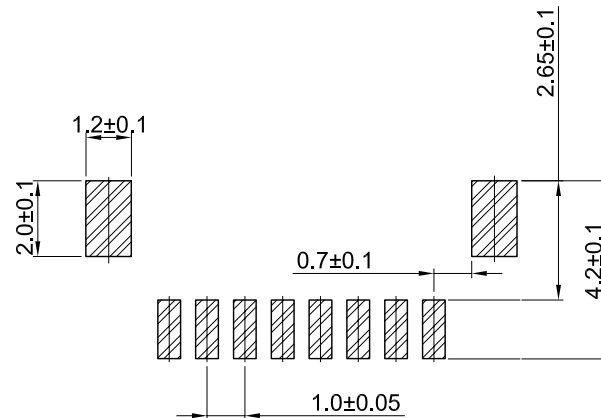

**P.C.B. LAYOUT**

**Order Information :**

HWJ41 - 083 TNC0 1 - R  
 1 2 3 4 5 6 7 8

1. SERIES NUMBER	HWJ41 : 1.00mm PITCH WIRE TO BOARD WAFER STRAIGHT SMD
2. POSITION	02 ~ 15 & 20
3. CONTACT MATERIAL	3 : PHOSPHOR BRONZE
4. CONTACT PLATING	T : TIN
5. INSULATOR COLOR	N : NATURE
6. INSULATOR MATERIAL	C : NYLON
7. PACKING	1 : TUBE 2 : W/CAP TAPE & REEL
8. GREEN PRODUCT	R : RoHS



維鼎股份有限公司  
 WEKANG CO., LTD.  
 TEL:886-2-26436301 FAX:886-2-26432714

GENERAL TOLERANCE  
 X.X ± 0.25  
 X.XX ± 0.15

ANGLE TOLERANCE ± 1°  
 RADIUS ± 0.25  
 HOLE ± 0.13

DRAWN. JEAN  
 CHECKED. HENRY  
 APPROVED. HENRY

DATE 12 - 30 - 2005  
 DATE 12 - 30 - 2005  
 DATE 12 - 30 - 2005

DRAWING NO. HWJ41-XX3TNC0X-R C04001  
 TITLE. 1.00mm PITCH WIRE TO BOARD WAFER STRAIGHT SMD  
 PART NO. HWJ41-XX3TNC0X-R REV A.0

SIZE A4 UNIT mm SCALE. SHEET. 1 OF 1