

|      |      |      |     |      |
|------|------|------|-----|------|
| REV. | ECN. | DATE | DWN | APVD |
|      |      |      |     |      |

### MATERIAL:

INSULATOR : PBT + GLASS FIBER (UL 94V-0)  
 CONTACT : COPPER ALLOY  
 CONTACT FINISH : GOLD OVER NICKEL

### SPECIFICATION:

CURRENT RATING : 3A  
 DIELECTRIC WITHSTANDING VOLTAGE : 500V AC PER MINUTE  
 INSULATION RESISTANCE : 1000MΩ MIN.  
 CONTACT RESISTANCE : 30mΩ MAX.  
 OPERATING TEMPERATURE : -40°C ~ +105°C.

### Order Information :

HPB11 1 / 2 - 0 / 8 1 / 4 A / 5 B / 6 0 / 7 0 / 8 - R / 9

|                          |  |
|--------------------------|--|
| 1. SERIES NUMBER         | HPB11 : 2.54mm PITCH PIN HEADER STRAIGHT TYPE  |
| 2. ROW TYPE              | 1 : SINGLE ROW   |
| 3. POSITION PER ROW      | 02 ~ 40  |
| 4. CONTACT MATERIAL      | 1 : COPPER ALLOY   |
| 5. CONTACT PLATING       | 1 : SELECTIVE GOLD FLASH<br>4 : SELECTIVE GOLD 15u"<br>6 : SELECTIVE GOLD 30u"<br>A : FULL GOLD FLASH<br>T : TIN |
| 6. INSULATOR MATERIAL    | B : PBT<br>C : NYLON   |
| 7. INSULATOR HEIGHT      | 0 : 2.54mm   |
| 8. PIN TAIL LENGTH (A/B) | 01 : 6.0 / 3.0<br>A/B : CUSTOM LENGTH AVAILABLE  |
| 9. GREEN PRODUCT         | BLANK : NOT GREEN PRODUCT<br>R : RoHS  |

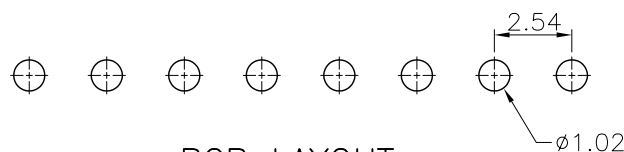
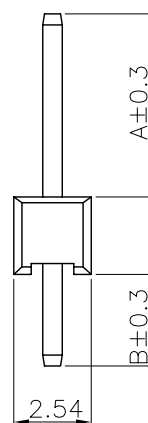
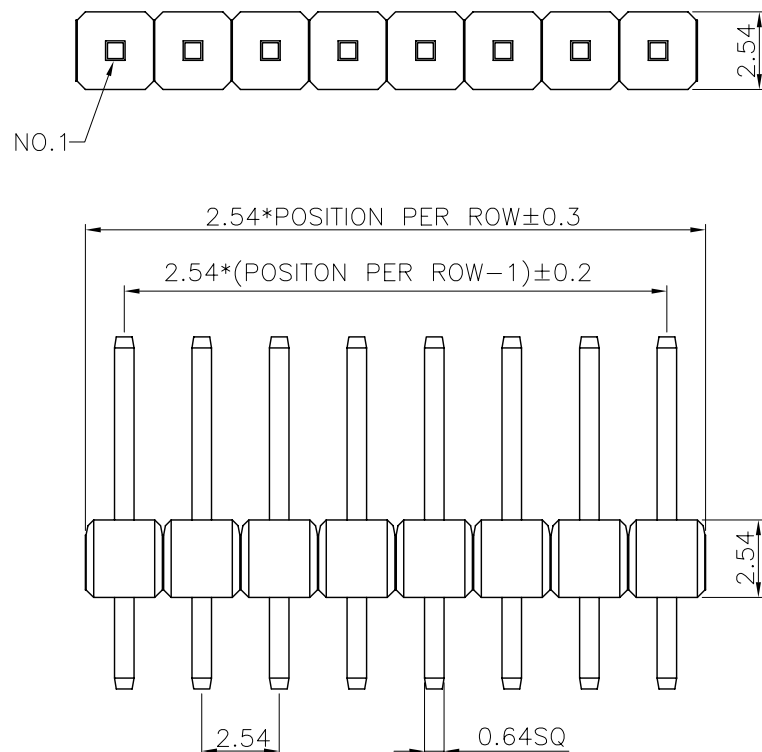

PCB LAYOUT

| PIN CODE | TAIL LENGTH A | LENGTH B |
|----------|---------------|----------|
| 01       | 6.0           | 3.0      |
|          |               |          |
|          |               |          |
|          |               |          |

**WEKANG CO., LTD.**  
 維鼎股份有限公司  
 TEL:886-2-26436301 FAX:886-2-26432714

|         |         |             |              |
|---------|---------|-------------|--------------|
| SIZE A4 | UNIT mm | SCALE 4 / 1 | SHEET 1 OF 1 |
|---------|---------|-------------|--------------|

GENERAL TOLERANCE  
 X.X ± 0.25  
 X.XX ± 0.15  
 X.XXX ± 0.05  
 ANGLE TOLERANCE ± 1°  
 RADIUS ± 0.25  
 HOLE ± 0.13

|           |       |      |                |
|-----------|-------|------|----------------|
| DRAWN.    | JEAN  | DATE | 12 - 14 - 2005 |
| CHECKED.  | HENRY | DATE | 12 - 16 - 2005 |
| APPROVED. | HENRY | DATE | 12 - 16 - 2005 |

|             |   |         |
|-------------|---|---------|
| DRAWING NO. | HPB111-XX1XX001-R                                 | C04010  |
| TITLE.      | 2.54mm PITCH PIN HEADER STRAIGHT TYPE, SINGLE ROW |         |
| PART NO.    | HPB111-XX1XX001-R                                 | REV A.0 |

|      |      |      |     |      |
|------|------|------|-----|------|
| REV. | ECN. | DATE | DWN | APVD |
|      |      |      |     |      |

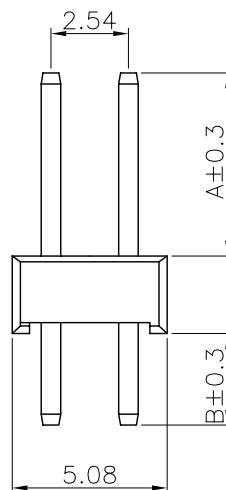
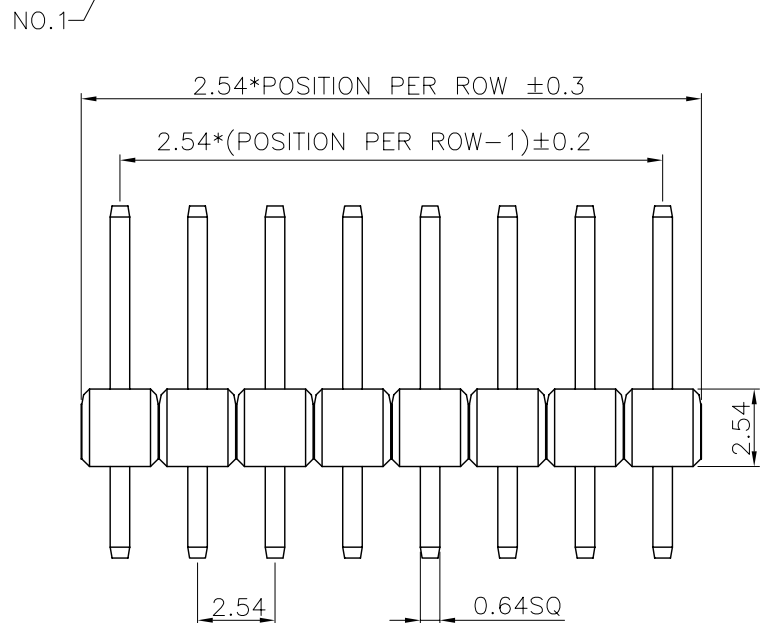
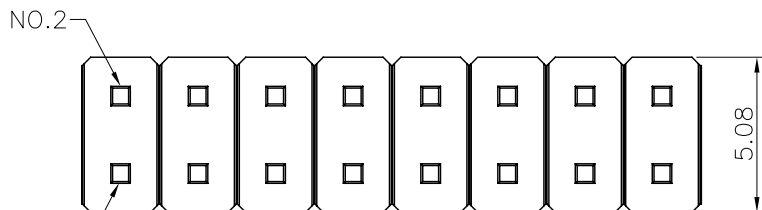

| PIN CODE | TAIL A | LENGTH B |
|----------|--------|----------|
| 01       | 6.0    | 3.0      |
|          |        |          |
|          |        |          |
|          |        |          |

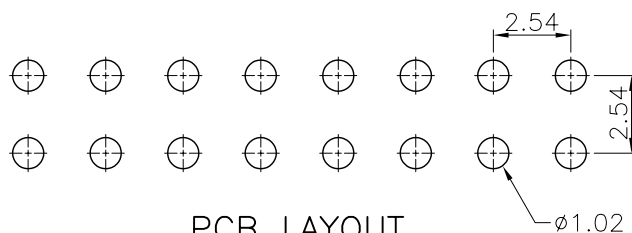

### MATERIAL:

INSULATOR : PBT + GLASS FIBER (UL 94V-0)  
 CONTACT : COPPER ALLOY  
 CONTACT FINISH : GOLD OVER NICKEL

### SPECIFICATION:

CURRENT RATING : 3A  
 DIELECTRIC WITHSTANDING VOLTAGE : 500V AC PER MINUTE  
 INSULATION RESISTANCE : 1000MΩ MIN.  
 CONTACT RESISTANCE : 30mΩ MAX.  
 OPERATING TEMPERATURE : -40°C ~ +105°C.

### Order Information :

HPB11  $\frac{2}{1}$  -  $\frac{1}{3}$   $\frac{6}{4}$   $\frac{1}{5}$   $\frac{A}{6}$   $\frac{B}{7}$   $\frac{0}{8}$   $\frac{0}{8}$   $\frac{1}{8}$  -  $\frac{R}{9}$

|                          |  |
|--------------------------|--|
| 1. SERIES NUMBER         | HPB11 : 2.54mm PITCH PIN HEADER STRAIGHT TYPE  |
| 2. ROW TYPE              | 2 : DUAL ROW   |
| 3. POSITION PER ROW      | 02 ~ 40  |
| 4. CONTACT MATERIAL      | 1 : COPPER ALLOY   |
| 5. CONTACT PLATING       | 1 : SELECTIVE GOLD FLASH<br>4 : SELECTIVE GOLD 15u"<br>6 : SELECTIVE GOLD 30u"<br>A : FULL GOLD FLASH<br>T : TIN |
| 6. INSULATOR MATERIAL    | B : PBT<br>C : NYLON   |
| 7. INSULATOR HEIGHT      | 0 : 2.54mm   |
| 8. PIN TAIL LENGTH (A/B) | 01 : 6.0 / 3.0<br>A/B : CUSTOM LENGTH AVAILABLE  |
| 9. GREEN PRODUCT         | BLANK : NOT GREEN PRODUCT<br>R : RoHS  |

**WEKANG CO., LTD.**  
 維鼎股份有限公司  
 TEL:886-2-26436301 FAX:886-2-26432714

|         |         |             |              |
|---------|---------|-------------|--------------|
| SIZE A4 | UNIT mm | SCALE 4 / 1 | SHEET 1 OF 1 |
|---------|---------|-------------|--------------|

GENERAL TOLERANCE  
 X.X ±0.25  
 X.XX ±0.15  
 X.XXX ±0.05  
 ANGLE TOLERANCE ±1°  
 RADIUS ±0.25  
 HOLE ±0.13

|           |       |      |                |
|-----------|-------|------|----------------|
| DRAWN.    | JEAN  | DATE | 12 - 14 - 2005 |
| CHECKED.  | HENRY | DATE | 12 - 16 - 2005 |
| APPROVED. | HENRY | DATE | 12 - 16 - 2005 |

|             |   |         |
|-------------|---|---------|
| DRAWING NO. | HPB112-XX1XX001-R                               | C04010  |
| TITLE.      | 2.54mm PITCH PIN HEADER STRAIGHT TYPE, DUAL ROW |         |
| PART NO.    | HPB112-XX1XX001-R                               | REV A.0 |

| REV. | ECN.          | DATE     | DWN   | APVD  |
|------|---------------|----------|-------|-------|
| A.1  | ECN-060426-1  | 04/26/06 | 謝炎忠   | HENRY |
| A.2  | ECN-080128-01 | 02/26/08 | TRACY | HENRY |

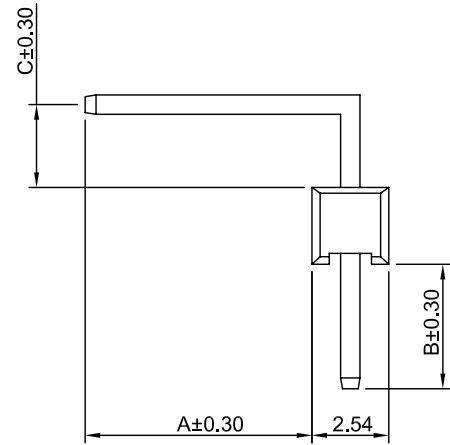
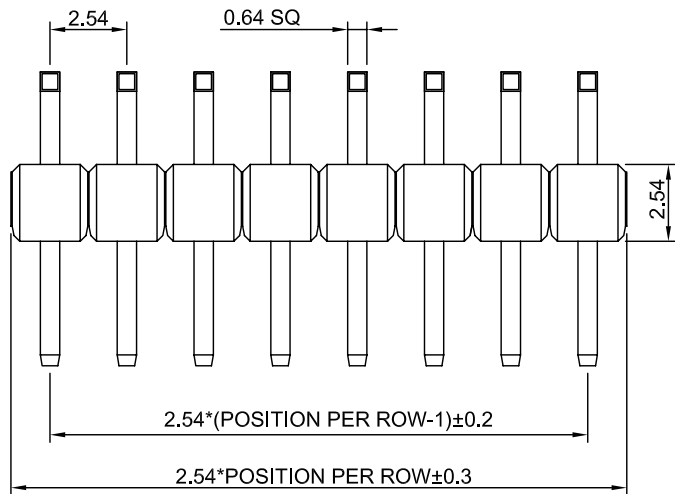

**MATERIAL:**

INSULATOR : THERMOPLASTIC ,UL 94V-0.  
 STANDARD : PBT.  
 CONTACT : COPPER ALLOY.  
 CONTACT FINISH : GOLD OVER NICKEL.

**SPECIFICATION:**

CURRENT RATING : 3 AMP.  
 DIELECTRIC WITHSTANDING VOLTAGE : 500V AC FOR 1 MINUTE.  
 INSULATION RESISTANCE : 1000MΩ MIN. AT 500V DC.  
 CONTACT RESISTANCE : 30mΩ MAX.  
 OPERATING TEMPERATURE : -40°C ~ +105°C.

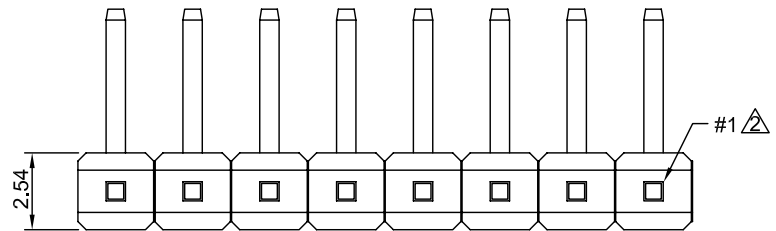

**ORDER INFORMATION :**

HPB311 - 16 1 A B 0 0 1 - R  
 1 2 3 4 5 6 7 8 9

- |                        |                               |
|------------------------|-------------------------------|
| 1. SERIES:             | 6. INSULATOR MATERIAL:        |
| 2. ROW TYPE:           | B=PBT                         |
| 1=SINGLE ROW           | C=NYLON                       |
| 3. POSITION PER ROW:   | 7. INSULATOR HEIGHT:          |
| 02~40                  | 0=2.54mm                      |
| 4. CONTACT MATERIAL:   | 8. PIN TAIL LENGTH(A/B/C):    |
| 1=COPPER ALLOY         | 01=7.0 / 3.0 / 2.74           |
| 5. CONTACT PLATING:    | A/B/C:CUSTOM LENGTH AVAILABLE |
| 1=SELECTIVE GOLD FLASH | 9. GREEN PRODUCT:             |
| 4=SELECTIVE 15u" GOLD  | R=RoHS COMPLIANT              |
| 6=SELECTIVE 30u" GOLD  |                               |
| A=FULL GOLD FLASH      |                               |
| T=TIN                  |                               |

| PIN TAIL LENGTH |     |     |       |
|-----------------|-----|-----|-------|
| CODE            | A   | B   | C     |
| 01              | 7.0 | 3.0 | △2.74 |
|                 |     |     |       |
|                 |     |     |       |
|                 |     |     |       |

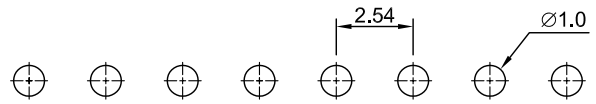

PCB LAYOUT ±0.1mm

 **WEKANG CO., LTD.**  
<http://www.wekang.com>

|            |            |                 |                  |
|------------|------------|-----------------|------------------|
| SIZE<br>A4 | UNIT<br>mm | SCALE.<br>4 : 1 | SHEET.<br>1 OF 1 |
|------------|------------|-----------------|------------------|

GENERAL TOLERANCE  
 X.X ±0.25  
 X.XX ±0.15  
 X.XXX ±0.05  
 ANGLE TOLERANCE ± 1°  
 RADIUS ± 0.25  
 HOLE ± 0.13

DRAWN. JEAN  
 CHECKED. HENRY  
 APPROVED. HENRY

DATE 12 - 14 - 2005  
 DATE 12 - 16 - 2005  
 DATE 12 - 16 - 2005

DRAWING NO. C-HP0014  
 TITLE. 2.54mm PITCH PIN HEADER RIGHT ANGLE TYPE, SINGLE ROW  
 PART NO. HPB311-XX1XX0XX-R

CUSTOMER DRAWING  
 REV A.2

| REV. | ECN.          | DATE     | DWN   | APVD  |
|------|---------------|----------|-------|-------|
| A.1  | ECN-080128-01 | 02/26/08 | TRACY | HENRY |

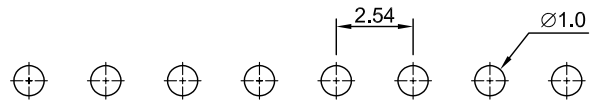
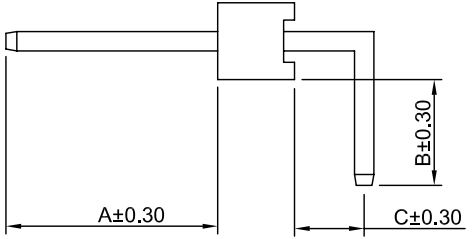
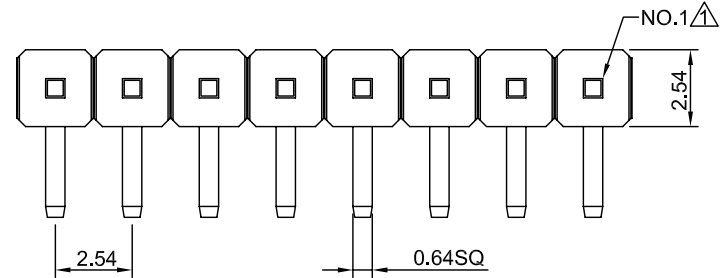
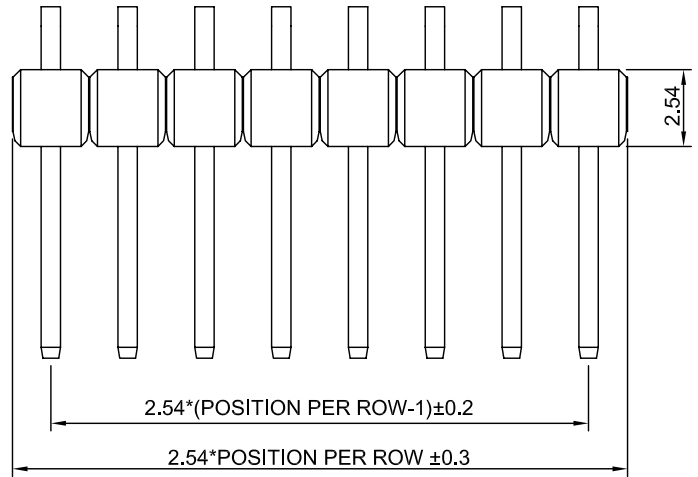

PCB LAYOUT ±0.1mm

| PIN TAIL LENGTH |     |     |      |
|-----------------|-----|-----|------|
| CODE            | A   | B   | C    |
| 01              | 6.0 | 3.0 | 1.54 |
|                 |     |     |      |
|                 |     |     |      |

**MATERIAL:**

INSULATOR : THERMOPLASTIC ,UL 94V-0.  
 STANDARD : PBT.  
 CONTACT : COPPER ALLOY.  
 CONTACT FINISH : GOLD OVER NICKEL.

**SPECIFICATION:**

CURRENT RATING : 3 AMP.  
 DIELECTRIC WITHSTANDING VOLTAGE : 500V AC FOR 1 MINUTE.  
 INSULATION RESISTANCE : 1000MΩ MIN. AT 500V DC.  
 CONTACT RESISTANCE : 30mΩ MAX.  
 OPERATING TEMPERATURE : -40°C ~ +105°C.

**ORDER INFORMATION :**

HPB911 - 16 1 A B 0 0 1 - R  
 1 2 3 4 5 6 7 8 9

- |                        |                               |
|------------------------|-------------------------------|
| 1. SERIES:             | 6. INSULATOR MATERIAL:        |
| 2. ROW TYPE:           | B=PBT                         |
| 1=SINGLE ROW           | C=NYLON                       |
| 3. POSITION PER ROW:   | 7. INSULATOR HEIGHT:          |
| 02~40                  | 0=2.54mm                      |
| 4. CONTACT MATERIAL:   | 8. PIN TAIL LENGTH(A/B/C):    |
| 1=COPPER ALLOY         | 01=6.0 / 3.0 / 1.54           |
| 5. CONTACT PLATING:    | A/B/C:CUSTOM LENGTH AVAILABLE |
| 1=SELECTIVE GOLD FLASH | 9. GREEN PRODUCT:             |
| 4=SELECTIVE 15u" GOLD  | R=RoHS COMPLIANT              |
| 6=SELECTIVE 30u" GOLD  |                               |
| A=FULL GOLD FLASH      |                               |
| T=TIN                  |                               |

**WEKANG CO., LTD.**  
<http://www.wekang.com>

|            |            |                 |                  |
|------------|------------|-----------------|------------------|
| SIZE<br>A4 | UNIT<br>mm | SCALE.<br>4 : 1 | SHEET.<br>1 OF 1 |
|------------|------------|-----------------|------------------|

GENERAL TOLERANCE  
 X.X ± 0.25  
 X.XX ± 0.15  
 X.XXX ± 0.05  
 ANGLE TOLERANCE ± 1°  
 RADIUS ± 0.25  
 HOLE ± 0.13

DRAWN. JEAN  
 CHECKED. HENRY  
 APPROVED. HENRY

DATE 12 - 14 - 2005  
 DATE 12 - 15 - 2005  
 DATE 12 - 15 - 2005

DRAWING NO. C-HP0015  
 TITLE. 2.54mm PITCH PIN HEADER RIGHT ANGLE TYPE, SINGLE ROW  
 PART NO. HPB911-XX1XX0XX-R

CUSTOMER DRAWING  
 REV A.1

| REV. | ECN.          | DATE     | DWN   | APVD  |
|------|---------------|----------|-------|-------|
| A.1  | ECN-080128-01 | 02/26/08 | TRACY | HENRY |

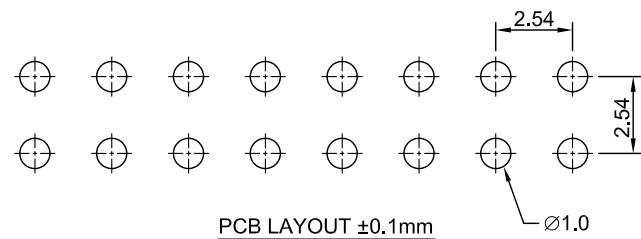
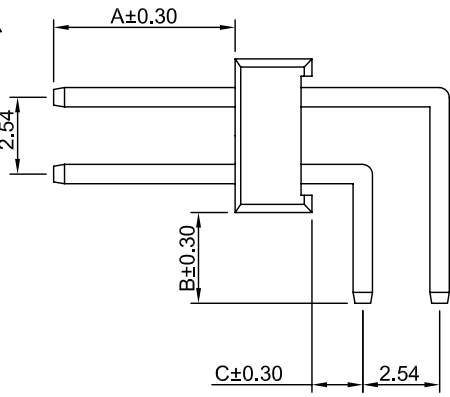
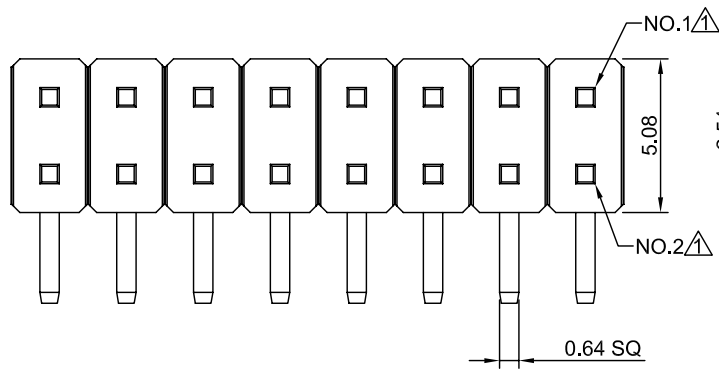
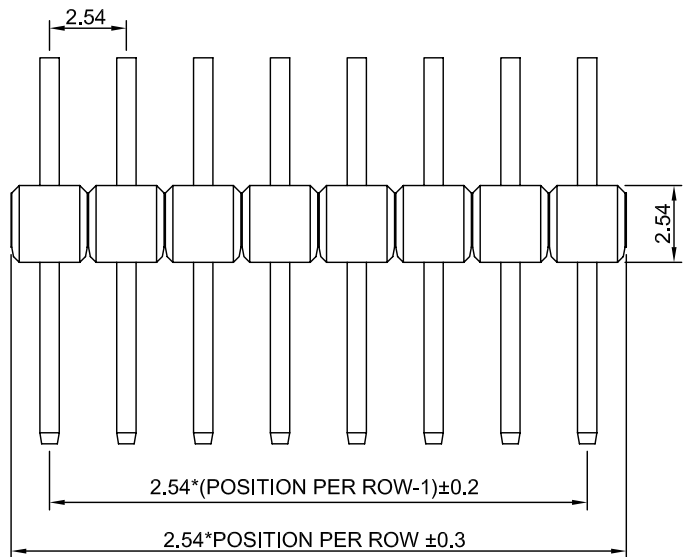

| PIN TAIL LENGTH |     |     |      |
|-----------------|-----|-----|------|
| CODE            | A   | B   | C    |
| 01              | 6.0 | 3.0 | 1.54 |
|                 |     |     |      |
|                 |     |     |      |
|                 |     |     |      |

**MATERIAL:**

INSULATOR : THERMOPLASTIC ,UL 94V-0.  
 STANDARD : PBT.  
 CONTACT : COPPER ALLOY.  
 CONTACT FINISH : GOLD OVER NICKEL.

**SPECIFICATION:**

CURRENT RATING : 3 AMP.  
 DIELECTRIC WITHSTANDING VOLTAGE : 500V AC FOR 1 MINUTE.  
 INSULATION RESISTANCE : 1000MΩ MIN. AT 500V DC.  
 CONTACT RESISTANCE : 30mΩ MAX.  
 OPERATING TEMPERATURE : -40°C ~ +105°C.

**ORDER INFORMATION :**

HPB912 - 16 1 A B 0 0 1 - R  
 1 2 3 4 5 6 7 8 9

- |                        |                               |
|------------------------|-------------------------------|
| 1. SERIES:             | 6. INSULATOR MATERIAL:        |
| 2. ROW TYPE:           | B=PBT                         |
| 2=DUAL ROW             | C=NYLON                       |
| 3. POSITION PER ROW:   | 7. INSULATOR HEIGHT:          |
| 02~40                  | 0=2.54mm                      |
| 4. CONTACT MATERIAL:   | 8. PIN TAIL LENGTH(A/B/C):    |
| 1=COPPER ALLOY         | 01=6.0 / 3.0 / 1.54           |
| 5. CONTACT PLATING:    | A/B/C:CUSTOM LENGTH AVAILABLE |
| 1=SELECTIVE GOLD FLASH | 9. GREEN PRODUCT:             |
| 4=SELECTIVE 15u" GOLD  | R=RoHS COMPLIANT              |
| 6=SELECTIVE 30u" GOLD  |                               |
| A=FULL GOLD FLASH      |                               |
| T=TIN                  |                               |

**WEKANG CO., LTD.**  
<http://www.wekang.com>

|            |            |                 |                  |
|------------|------------|-----------------|------------------|
| SIZE<br>A4 | UNIT<br>mm | SCALE.<br>4 : 1 | SHEET.<br>1 OF 1 |
|------------|------------|-----------------|------------------|

GENERAL TOLERANCE  
 X.X ± 0.25  
 X.XX ± 0.15  
 X.XXX ± 0.05  
 ANGLE TOLERANCE ± 1°  
 RADIUS ± 0.25  
 HOLE ± 0.13

DRAWN. JEAN  
 CHECKED. HENRY  
 APPROVED. HENRY

DATE 12 - 14 - 2005  
 DATE 12 - 16 - 2005  
 DATE 12 - 16 - 2005

DRAWING NO. C-HP0016  
 TITLE. 2.54mm PITCH PIN HEADER RIGHT ANGLE TYPE, DUAL ROW  
 PART NO. HPB912-XX1XX0XX-R

CUSTOMER DRAWING  
 REV A.1