

REV.	ECN.	DATE	DWN	APVD

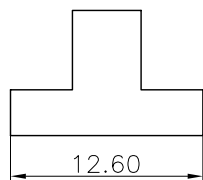
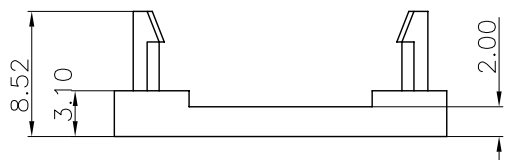
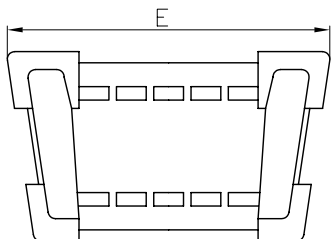
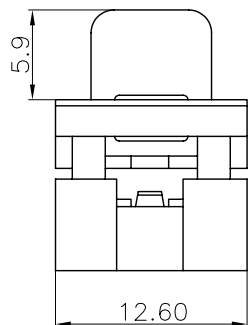
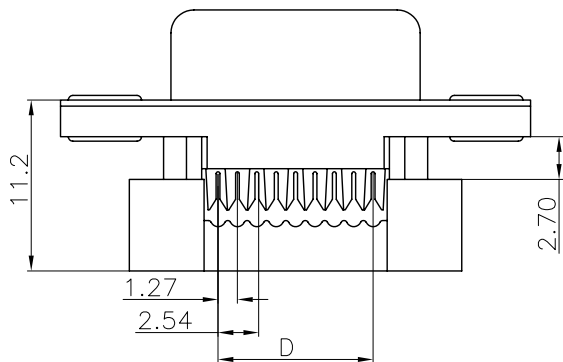
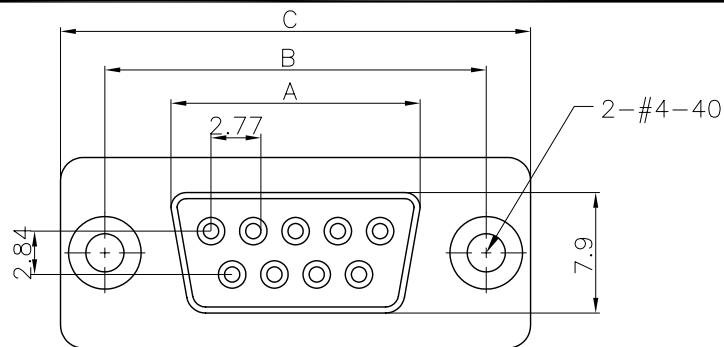

STRAN RELIEF

POSITION	A±0.20	B±0.20	C±0.38	D	E
09 Pin	16.30	25.00	30.80	10.16	21.78
15 Pin	24.60	33.30	39.20	17.78	29.62
25 Pin	38.35	47.05	53.05	30.48	43.35
37 Pin	54.80	63.50	69.40	45.72	59.92

### MATERIAL:

INSULATOR : PBT+30% GLASS FIBER (UL 94V-0)  
 CONTACT : PHOSPHOR BRONZE  
 CONTACT FINISH : GOLD OVER NICKEL  
 SHELL : STEEL ,NICKEL OR TIN PLATED

### SPECIFICATION:

CURRENT RATING : 5A  
 DIELECTRIC WITHSTANDING VOLTAGE : 1000V AC FOR 1 MINUTE  
 INSULATION RESISTANCE : 1000MΩ MIN. AT 500V DC  
 CONTACT RESISTANCE : 15mΩ MAX.  
 OPERATING TEMPERATURE : -55°C ~ +105°C.  
 WIRE SIZE : AWG26 ~ AWG28

### Order Information :

DB61 - 09 2 1 1 B 2 1 4 - R  
 1 2 3 4 5 6 7 8 9 10

1. SERIES NUMBER	DB61 : D-SUB I.D.C. TYPE FOR FLAT CABLE
2. POSITION	09 15 25 37
3. CONTACT TYPE	2 : FEMALE
4. CONTACT PLATING	1 : SELECTIVE GOLD 3 : SELECTIVE GOLD 10u" 6 : SELECTIVE GOLD 30u"
5. INSULATOR COLOR	1 : BLACK 7 : BLUE
6. INSULATOR MATERIAL	B : PBT
7. SHELL PLATING	0 : ALL PLASTIC 1 : NICKEL 2 : TIN 3 : ZINC
8. S.R. OPTION	0 : W/O STRAIN RELIEF 1 : WITH STRAIN RELIEF
9. MATING AND MOUNTING OPTIONS	0 : THROUGH HOLE ONLY 4 : 4-40 THREADED RIVETED
10. GREEN PRODUCT	BLANK : NOT GREEN PRODUCT R : RoHS COMPLIANT

**WEKANG CO., LTD.**  
 維鼎股份有限公司  
 TEL:886-2-26436301 FAX:886-2-26432714

SIZE A4	UNIT mm	SCALE 2/1	SHEET 1 OF 1
---------	---------	-----------	--------------

GENERAL TOLERANCE  
 X.X ±0.25  
 X.XX ±0.15  
 X.XXX ±0.05  
 ANGLE TOLERANCE ±1°  
 RADIUS ±0.25  
 HOLE ±0.13

DRAWN.	JEAN	DATE	11 - 15 - 2005
CHECKED.	HENRY	DATE	11 - 23 - 2005
APPROVED.	HENRY	DATE	11 - 23 - 2005

DRAWING NO.	DB61-XX2XXXX14-R	C14010
TITLE.	D-SUB I.D.C. TYPE FOR FLAT CABLE	
PART NO.	DB61-XX2XXXX14-R	REV A.0

REV.	ECN.	DATE	DWN	APVD

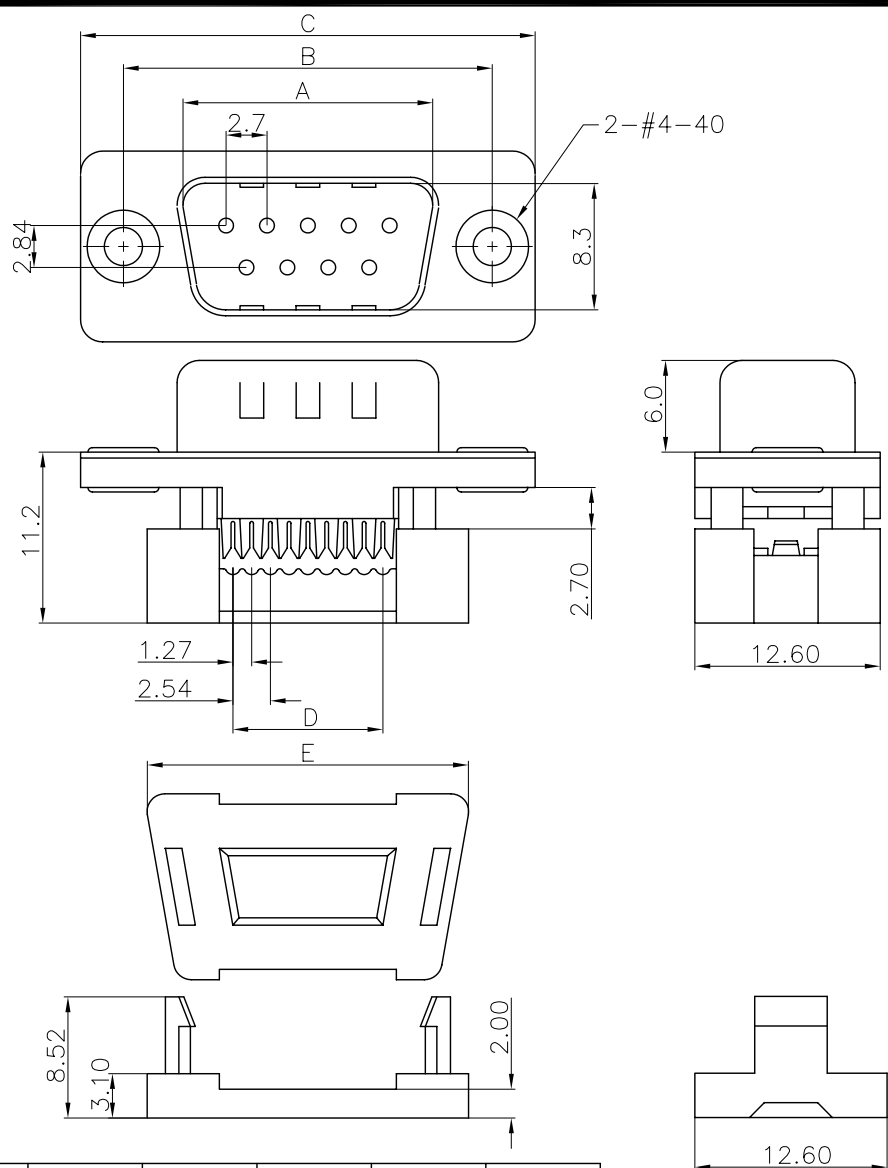

POSITION	A±0.20	B±0.20	C±0.38	D	E
09 Pin	16.90	25.00	30.80	10.16	21.78
15 Pin	25.25	33.30	39.20	17.78	29.62
25 Pin	38.95	47.05	53.05	30.48	43.35
37 Pin	55.40	63.50	69.40	45.72	59.92

STRAN RELIEF

**MATERIAL:**

INSULATOR : PBT+30% GLASS FIBER (UL 94V-0)  
 CONTACT : PHOSPHOR BRONZE  
 CONTACT FINISH : GOLD OVER NICKEL  
 SHELL : STEEL ,NICKEL OR TIN PLATED

**SPECIFICATION:**

CURRENT RATING : 5A  
 DIELECTRIC WITHSTANDING VOLTAGE : 1000V AC FOR 1 MINUTE  
 INSULATION RESISTANCE : 1000MΩ MIN. AT 500V DC  
 CONTACT RESISTANCE : 15mΩ MAX.  
 OPERATING TEMPERATURE : -55°C ~ +105°C.  
 WIRE SIZE : AWG26 ~ AWG28

**Order Information :**

DB61 - 09 3 1 1 B 2 1 4 - R  
 1 2 3 4 5 6 7 8 9 10

1. SERIES NUMBER	DB61 : D-SUB I.D.C. TYPE FOR FLAT CABLE
2. POSITION	09 15 25 37
3. CONTACT TYPE	3 : MALE
4. CONTACT PLATING	1 : SELECTIVE GOLD 3 : SELECTIVE GOLD 10u" 6 : SELECTIVE GOLD 30u"
5. INSULATOR COLOR	1 : BLACK 7 : BLUE
6. INSULATOR MATERIAL	B : PBT
7. SHELL PLATING	0 : ALL PLASTIC 1 : NICKEL 2 : TIN 3 : ZINC
8. S.R. OPTION	0 : W/O STRAIN RELIEF 1 : WITH STRAIN RELIEF
9. MATING AND MOUNTING OPTIONS	0 : THROUGH HOLE ONLY 4 : 4-40 THREADED RIVETED
10. GREEN PRODUCT	BLANK : NOT GREEN PRODUCT R : RoHS COMPLIANT

**WEKANG CO., LTD.**  
 維鼎股份有限公司  
 TEL:886-2-26436301 FAX:886-2-26432714

SIZE A4	UNIT mm	SCALE 2/1	SHEET 1 OF 1	
---------	---------	-----------	--------------	--

GENERAL TOLERANCE X.X ±0.25 X.XX ±0.15 X.XXX ±0.05 ANGLE TOLERANCE ±1° RADIUS ±0.25 HOLE ±0.13	DRAWN. JEAN	DATE 11 - 15 - 2005	DRAWING NO. DB61-XX3XXXX14-R	C14010
	CHECKED. HENRY	DATE 11 - 25 - 2005	TITLE. D-SUB I.D.C. TYPE FOR FLAT CABLE	
	APPROVED. HENRY	DATE 11 - 25 - 2005	PART NO. DB61-XX3XXXX14-R	REV A.0